

Vitotrol 100-E

Wireless remote control for 1 heating circuit

VITOTROL 100-E



Safety instructions

-  Please follow these safety instructions closely to prevent accidents and material losses.

Safety instructions explained

-  **Danger**
This symbol warns against the risk of injury.

Note
Details identified by the word "Note" contain additional information.

Target group

These instructions are intended for system users.

This appliance can also be operated by children aged 8 and older, as well as by individuals with reduced physical, sensory or mental faculties or those lacking in experience and knowledge, provided such individuals are supervised or have been instructed in the safe use of this appliance and any risks arising from it.

-  **Danger**
Wireless signals can interfere with electronic medical devices, particularly pacemakers, hearing aids and defibrillators. If any such equipment is fitted, users should avoid being in the immediate vicinity of operational wireless components.

Installation and adjustment

- All settings and work on the device must be carried out as specified in these instructions.
- Observe minimum clearances to ensure reliable signal transmission.

Operation of the system



- Only operate the devices inside closed buildings.
- Never operate devices in rooms where there is a risk of explosion.
- Protect devices from:
 - Moisture
 - Dust
 - Liquids
 - Vapours
 - Direct sunlight
 - Other direct thermal radiation
- After a restart, check the status of the wireless components.

-  **Danger**
Damaged equipment poses a safety hazard. Check the appliance for external damage. Never start up a damaged appliance.

Safety instructions (cont.)

Auxiliary components and individual parts

For replacement, use only spare parts supplied or approved by Viessmann.

1. Safety and liability	Operational reliability and system requirements	6
	Liability	6
2. Introductory information	Disposal of packaging	7
	Symbols	7
	Terminology	7
	Contractor	7
	Intended use	8
	Product information	8
	■ Maintenance parts and spare parts	8
	Commissioning	9
	■ Control unit of Viessmann appliance	9
	■ Remote control	9
	Your system has been preset	9
	Energy saving tips	9
	Tips for greater comfort	10
3. Preparing for installation	Installation location	11
	■ Checking the reception quality at the installation location	11
	■ Range of the wireless signal	11
	■ Angle of penetration	12
4. Installation sequence	Overview of the installation and commissioning process	13
	Fitting the mounting base	13
	Establishing a power supply via batteries	13
5. Commissioning	 Adjusting your Viessmann appliance	15
	■ Commissioning the Vitotrol 100-E	15
	■ Uninstalling the Vitotrol 100-E	15
	Inserting the Vitotrol 100-E in the mounting base	16
6. Using the remote control	Using the remote control	17
	■ Overview of controls	17
	■ Home screen	18
	■ Symbols on the display	18
	■ Standby	18
	■ Locking/unlocking the controls	19
	Operating programs for central heating and DHW heating	19
	■ Special operating programs and functions	20
	Procedure for setting a time program	20
	■ Time programs and time phases	20
	■ Setting time phases	21
	■ Deleting time phases	22
7. Central heating	Adjusting the room temperature	23
	■ Changing the room temperature for the current temperature level	23
	■ Changing the room temperature for further temperature levels	23
	■ Time program for central heating	23
	Switching central heating on or off	23
	Temporarily adjusting the room temperature	24
	■ Switching on "Extended heating"/"Extend time phase once" 	24
	■ Switching off " Extended heating "/"Extend time phase once"	24
8. DHW heating	Starting DHW heating	25
	■ Switching off DHW heating	25
	Setting the DHW temperature	25
	Time program for DHW heating	25
	■ Setting a time program	25

Index (cont.)

9. Further settings	Setting or changing the language	26
	Enabling the "Lock controls" (child lock) function	26
	■ Cancelling activation of the "Controls lock-out" (child lock) function ..	26
	Software update	26
	Setting the format of the day and time display	26
	Restoring factory settings	27
10. Diagnosis and service checks	Calling up device information	28
	■ Displaying " DEV INFO "	28
	Correcting the actual room temperature displayed	28
	Messages shown on the display	28
11. What to do if...	Faults without fault display	30
	Cause of fault could not be found	30
	Restarting the Vitotrol 100-E	30
12. Maintenance	Replacing the batteries	32
	Cleaning	33
13. Specification	34
14. Appendix	Licences	35
	■ APACHE-LIZENZ/Version 2.0	35
	Terminology	37
	■ Standby mode	37
	■ Setback mode (reduced heating mode)	37
	■ Operating program	37
	■ Screed drying	37
	■ Underfloor heating system	38
	■ Heating mode	38
	■ Heating circuit	38
	■ Night setback	38
	■ Room heating	38
	■ Room temperature	39
	■ Actual room temperature	39
	■ Set temperature	39
	■ Time program	39
	Final decommissioning and disposal of the remote control	39
15. Certification	40
16. Keyword index	41

Operational reliability and system requirements

System safety:

- The heating system and the functionality of the message paths must be tested at regular intervals.
- To improve the operational reliability of the heating system, we recommend implementing supplementary measures, e.g. frost protection or monitoring for water damage.

Reliable remote control operation:

- The control unit of the Viessmann appliance **and** the Vitotrol 100-E remote control must be connected via low power radio.
- At least 1 heating circuit must be assigned to the remote control (settings to be made by the contractor via software tool).

- Commissioning has been carried out.
- For a software update, the Viessmann appliance has to be connected to the internet via a WiFi router. The download always takes place via the Viessmann server. Automatic software updates are only carried out if a permanent internet connection is available via the Viessmann appliance (recommendation).



Settings for WiFi and low power radio at the connected Viessmann appliance:

Operating instructions for the Viessmann appliance

Liability

No liability is accepted for loss of profit, unattained savings, or other direct or indirect consequential losses resulting from use of the Vitotrol remote control, the Viessmann server or the software, or for damage resulting from inappropriate use.

Liability is limited to typical damage arising if a fundamental contractual obligation is violated through slight negligence, the fulfilment of which is essential for proper execution of the contract.









The limitation of liability shall not apply if the damage was caused deliberately or through gross negligence, or if mandatory liability applies due to product liability legislation.

The Viessmann General Terms and Conditions apply, which are included in each current Viessmann pricelist. Viessmann accepts no liability for push notifications and email services, which are provided by network operators. The terms and conditions of the relevant network operators apply in this context.

Disposal of packaging

Please dispose of packaging waste in line with statutory regulations.

Symbols

Symbol	Meaning
	Reference to other document containing further information
	Step in a diagram: The numbers correspond to the order in which the steps are carried out.
	Warning of material losses and environmental pollution
	Live electrical area
	Pay particular attention.
	<ul style="list-style-type: none"> ▪ Component must audibly click into place. or ▪ Acoustic signal
	<ul style="list-style-type: none"> ▪ Fit new component. or ▪ In conjunction with a tool: Clean the surface.
	Dispose of component correctly.
	Dispose of component at a suitable collection point. Do not dispose of component in domestic waste.

Terminology

To provide you with a better understanding of the functions of your remote control, some terminology is explained. This information can be found in chapter "Terminology" in the Appendix.

Contractor



Activities that may only be carried out by the contractor are indicated with this symbol.

Work on electrical equipment may only be carried out by a qualified electrician.

Introductory information

Intended use

Install and operate the Vitotrol 100-E as intended and only in conjunction with the electronic control units and controllers of the Viessmann appliances that are supported for this purpose.

The Vitotrol 100-E is exclusively designed for operation in buildings of a residential or commercial nature. Incorrect use of the device is prohibited and will result in an exclusion of liability (e.g. commercial or industrial use other than for control and monitoring purposes).

Installation, service and operating instructions included with the product and available online must be observed.

Use the Vitotrol 100-E exclusively for system operation with the communication interfaces specified for this purpose in the relevant product documentation. With regard to the communication interfaces, ensure on site that the system requirements specified in the product documentation are met at all times for every transfer medium employed.

Note

The device is intended exclusively for domestic or semi-domestic use, i.e. even users who have not had any instruction are able to operate the device safely.

Product information

The Vitotrol 100-E is a wireless remote control for Viessmann appliances, e.g. heat generators. The Vitotrol 100-E is connected to the control unit of the Viessmann appliance via "low power radio". For operation with a Vitotrol 100-E, the control unit of the Viessmann appliance must be set to **"15: Individual room control (On/Off)"** or **"16: Individual room control with modulation (modulation control)"** during commissioning using the ViGuide software tool (depending on the remote control version).

1 heating circuit can be operated with the Vitotrol 100-E. The Vitotrol 100-E can be used to set room temperatures and operating programs, or call up fault messages.

Ambient temperatures: +5 to +40 °C

The Vitotrol 100-E may be used in rooms with moderate or low humidity.

Note

No more than 1 Vitotrol 100-E can be configured for each control unit.

In the case of the Vitodens 1xx and 050-W, only the first direct heating circuit without mixer is supported.

Up to date information on the remote control

For a current overview of the supported control units and updates for the product, e.g. information on commissioning: See **www.vitotrol.info**.

Maintenance parts and spare parts

Maintenance parts and spare parts can be identified and ordered directly online.

Viessmann Partnership

Login:

<https://shop.viessmann.com/>



Viessmann spare part app

www.viessmann.com/etapp



Commissioning

Control unit of Viessmann appliance

The commissioning and matching of the control unit to local conditions and building characteristics, as well as instructing the user in the operation of the system, is carried out by your contractor.

During commissioning, the control unit settings are transferred to the remote control.

Remote control

Commissioning of the Vitotrol 100-E: See page 14 15.

Your system has been preset

The control unit preset at the factory.



Operating instructions for the Viessmann appliance

The range of functions and displays on your remote control depends on the control unit it is connected to, its settings and the equipment of the system overall.

Your contractor can make further adjustments for you during commissioning.

You can change the settings at any time to suit your individual requirements.

Power failure

All settings are saved if there is a power failure.

Energy saving tips

Saving energy when using central heating

- Do not overheat your home. Every degree of room temperature reduction saves up to 6 % on your heating bills.
Do not set your individual preferred temperature too high, e.g. not above 20 °C: See page 23.
- Heat your home to the reduced room temperature at night or during regular absences (not applicable to underfloor heating). To do this, set the time programs for room heating.
- To switch off functions that are not required (e.g. central heating in summer), select the "Only DHW" and "Standby mode" operating programs.



Operating instructions for Viessmann heat generator

Saving energy on DHW heating

- At night or during regular absences, heat the DHW to a lower temperature. To do this, set the time program for DHW heating.
- Switch on DHW circulation only for those times in which you regularly use hot water. To do so, adjust the settings in the time program for the DHW circulation pump. This setting can only be made at the control unit of the Viessmann appliance.



Operating instructions for Viessmann heat generator

For additional energy saving functions, e.g. on the control unit, please contact your contractor.

Tips for greater comfort

More comfort in your home

- Set your individual preferred temperature: See page 23.
- Set the time program for your heating circuits such that your individual preferred temperature is automatically reached when you are present.
- If you need a higher room temperature for a short time, select the **"Extended heating""Extend time phase once"** function: See page 24 22.
Example: Late in the evening, the reduced room temperature is set by the time program. Your guests stay longer.

Sufficient DHW heating for your needs

- Set the time program for DHW heating such that there is always sufficient hot water for your usual needs: See page 25.
Example:
You need more DHW in the morning than in the day-time.
- Set the time program for the DHW circulation pump so that at times when hot water is used frequently, DHW is available immediately from the taps. This setting can only be made at the control unit of the Viessmann appliance.
 Operating instructions for Viessmann heat generator

Installation location

Install your remote control on a wall.

- Installation only in enclosed buildings
- The installation location must be dry and free of frost.
- Ensure ambient temperatures between +5 and +40 °C.
- Never seal off the vent apertures of the Vitotrol 100-E.
- Distance to floor min. 1.5 m
- Not next to windows or doors
- Not above radiators
- Not between shelves, in recesses, etc.
- Not near heat sources (direct insolation, fireplace, TV set, etc.)
- Away from vents

Checking the reception quality at the installation location

In order to check the reception quality at the intended installation location, first start the Vitotrol 100-E: See page 14 15.

Tap the following buttons:

1. 
2.  /  for "DEV INFO"
3. OK
4.  /  for "RF RANGE"
5. OK

The signal strength "RF RANGE" for this mounting position is displayed. For an explanation of the display: See the following table.

Meaning of display

Value in dBm	Reception quality
0 to -50	Very good
-51 to -65	Good
-66 to -75	Adequate
-76 to -85	Inadequate
-86 to -...	No reception

The values given in the table are meant as guide values. The connection may vary depending on local conditions.

Note

- *The poorer the reception quality, the longer it takes for the Vitotrol 100-E to establish a connection to the Viessmann appliance. It can take up to 6 minutes to establish the connection.*
- *A poor connection can result in the batteries running out sooner.*
- *To ensure a stable wireless connection, we recommend a signal strength of at least -75 dBm: See the following table.*

Range of the wireless signal

The range of wireless signals may be reduced by walls, ceilings and interior fixtures. These weaken the wireless signal, causing poor reception due to the following circumstances.

- On their way between transmitter and receiver, wireless signals are **damped**, e.g. by air or when penetrating walls.
- Wireless signals are **reflected** by metallic objects e.g. reinforcements embedded in walls, metal foil of thermal insulation and thermal glazing with metalised thermal vapour deposit.
- Wireless signals are **isolated** by service ducts and lift shafts.
- Wireless signals are **disrupted** by devices that also operate with high frequency signals. Maintain a distance of **at least 2 m** from these devices:
 - Computers
 - Audio and video systems
 - Devices with active WiFi connection
 - Electronic transformers
 - Pre-ballasts

To extend the range of the wireless signal, the following wireless repeaters can be used:

- Viessmann ViCare repeater for surface mounting
- Ubisys repeater

Angle of penetration

The reception quality remains best if radio signals hit the walls vertically.

Depending on the angle of penetration, the effective wall thickness changes and so does the extent to which the electromagnetic waves are damped.

Flat (unfavourable) angle of penetration

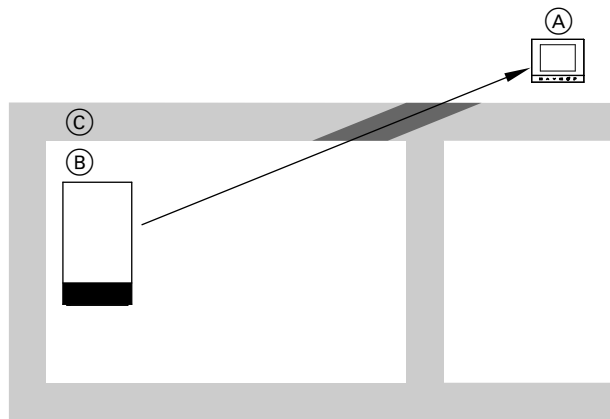

Fig. 1

- Ⓐ Vitotrol 100-E
- Ⓑ Viessmann appliance
- Ⓒ Wall

Ideal angle of penetration

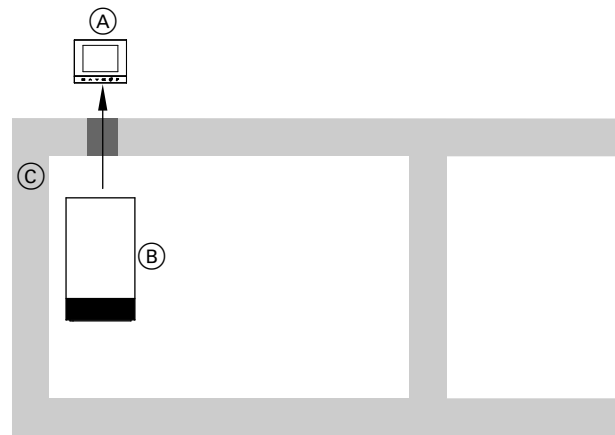

Fig. 2

- Ⓐ Vitotrol 100-E
- Ⓑ Viessmann appliance
- Ⓒ Wall

Overview of the installation and commissioning process

Steps		Responsibility	Page
1	Check system requirements.	Contractor IT expert	6
2	Fit the mounting base for the Vitotrol 100-E.	Contractor System user	13
3	Establish a power supply via batteries.	Contractor System user	13
4	Commission the Vitotrol 100-E.	Contractor	15
5	Insert the Vitotrol 100-E in the mounting base.	Contractor System operator	16

Fitting the mounting base

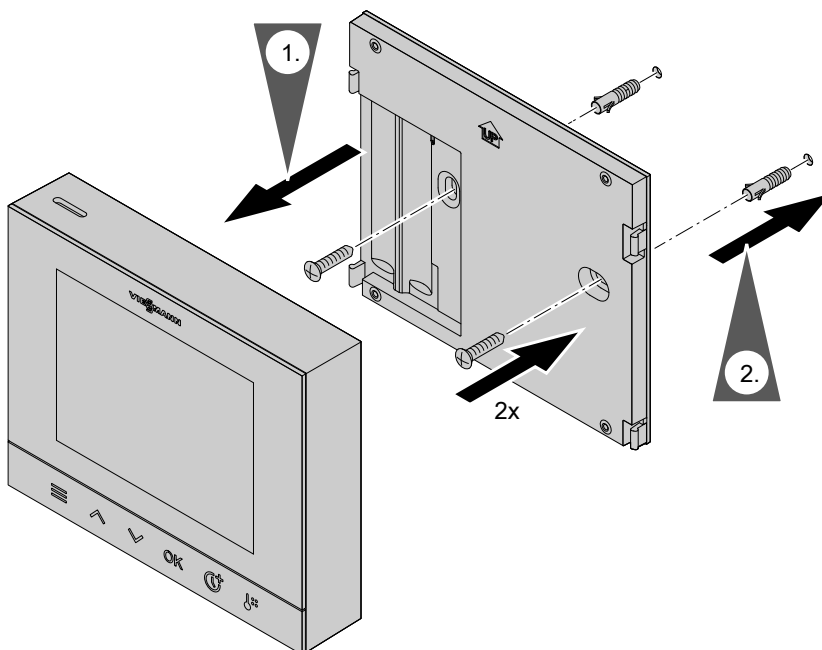

Fig. 3

Establishing a power supply via batteries

We recommend the use of AA batteries as they last longer than rechargeable ones.

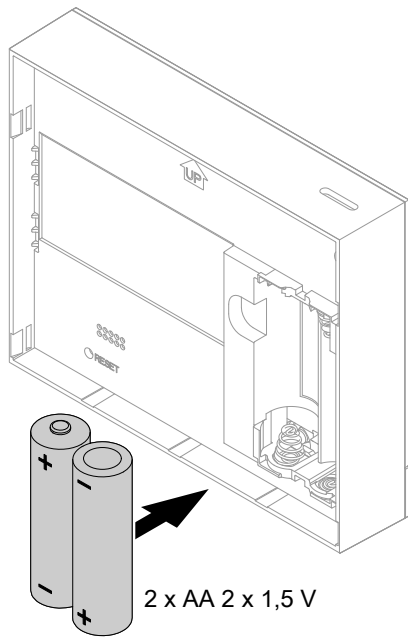

Fig. 4



Adjusting your Viessmann appliance

1. During commissioning, set the Viessmann appliance to "**15: Individual room control (On/Off)**" or "**16: Individual room control with modulation (modulation control)**" using the ViGuide software tool.
3. Install the ViGuide mobile app from the Apple App Store or Google Play Store on your mobile device.



Installation and service instructions of the Viessmann appliance

2. To connect your Viessmann appliance to the Vitotrol 100-E, activate "low power radio" at the control unit of your Viessmann appliance.
4. Launch the ViGuide mobile app.
5. Follow the instructions in the app to register.



Operating instructions for the Viessmann appliance

Commissioning the Vitotrol 100-E

After the batteries are inserted, the Vitotrol 100-E switches on and shows the following information on the display:

"**SW VERS**": Software version of the appliance

Press the following buttons:

1. **OK** for "**LANGUAGE**"
2. **▲** / **▼** to set the required language.
3. **OK** to confirm.
"**FORMAT**" is displayed.
4. **▲** / **▼** to select the required time format.
5. **OK** to confirm.
"**WEEK TYPE**" is displayed.
6. **▲** / **▼** to select whether days of the week should be displayed as "**NUMBER**" or "**WORD**".
7. **OK** to confirm.
"**STARTPAIR**" is displayed.
8. **OK** to confirm.
"**PAIRING**" is displayed.
While the connection to the Viessmann appliance is being established, a percentage progress indicator "**PROC**" is displayed.

9. Install the ViGuide mobile app from the Apple App Store or Google Play Store on your mobile device.
10. Launch the ViGuide mobile app.
11. Follow the instructions in the app to establish the connection to your Viessmann appliance.

Note

To cancel the connection attempt, press **≡**.

- The connection attempt is displayed via a progress bar in percent.
- It can take up to 6 minutes to establish the connection.
- The settings of the Viessmann appliance were transferred to the Vitotrol 100-E during commissioning.
- If the connection to your Viessmann appliance could not be established, the Vitotrol 100-E display will show "**RETRY**". Press **OK** to restart the connection attempt.

12. Adjust the settings of e.g. the set room temperature to match the system.

Uninstalling the Vitotrol 100-E

1. Install the ViGuide mobile app from the Apple App Store or Google Play Store on your mobile device.
2. Launch the ViGuide mobile app.
3. Follow the instructions in the app to remove the Vitotrol 100-E from the system.

Note

Further information on the ViGuide mobile app: See www.viguide.info

Inserting the Vitotrol 100-E in the mounting base

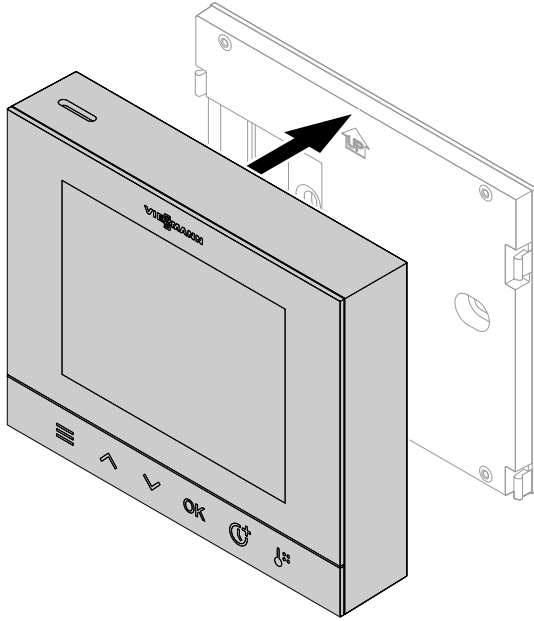

Fig. 5

Using the remote control

Overview of controls

The Vitotrol 100-E remote control enables you to adjust the following settings from the living space:

- Set room temperatures
- Time program heating
- DHW heating:
 - DHW temperature
 - Time program
- Heating circuit: Activate/deactivate "Extended heating"/"Extend time phase once"

All settings are transferred from the Vitotrol 100-E to the Viessmann appliance and vice versa. It is always the **most recent** settings that apply. During commissioning, the settings of the Viessmann appliance were already transferred to the remote control.

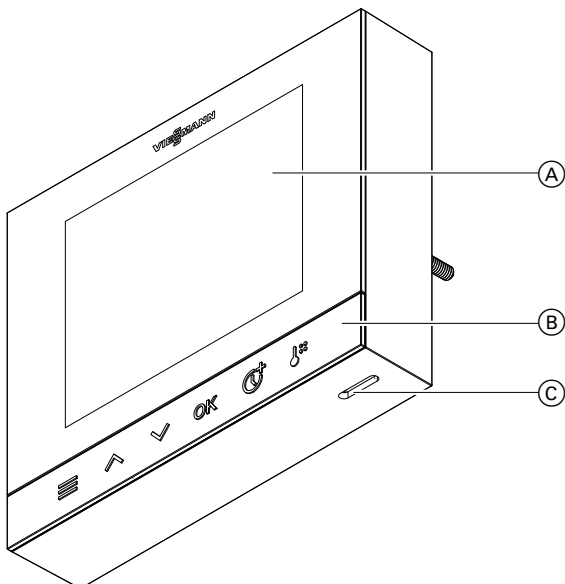

Fig. 6

- (A) Display
- (B) Operating buttons
- (C) Room temperature sensor aperture:
Never seal!

Operating buttons



- On the home screen:
Opens the settings menu.
If pressed for longer (approx. 3 seconds), the Vitotrol 100-E switches to standby mode.
- Within the settings menu:
Takes you one step back in the menu.
If pressed for longer (approx. 3 seconds), you return directly to the home screen without saving the settings you had made.



- Scrolls through the menu.
Confirms your selection or change.
On the home screen:
If pressed for longer (approx. 3 seconds), you activate/deactivate the operating buttons (child lock). The "Child lock" function must be activated once in the menu for this: See page 26.



- Activates/deactivates the **"Extended heating"/"Extend time phase once"** function.



- Takes you directly to the submenu, where you can set room temperatures for the temperature levels.

Home screen

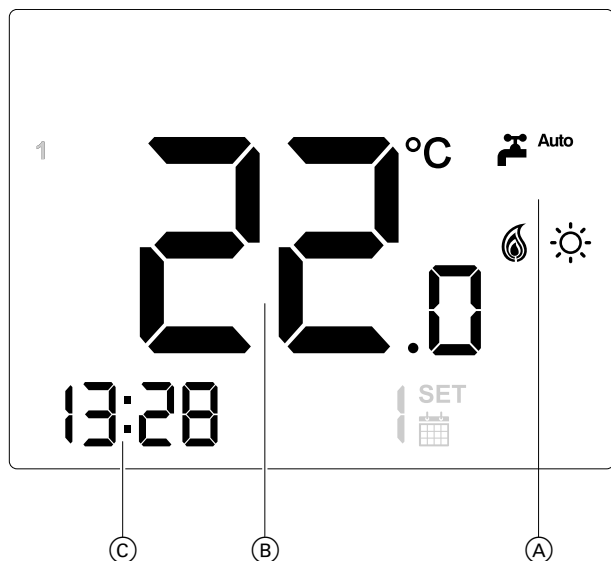

Fig. 7 Possible home screen, depending on the current operating state

- (A) Display of different symbols depending on the current operating state
- (B) Current actual room temperature
- (C) Current time

Symbols on the display

These symbols are not always displayed, but appear subject to the system version and the operating condition.

General symbols

- Indicates that the low power radio connection to the Viessmann appliance has been established.
- Child lock is active.

Temperatures

- Room heating with reduced room temperature
- Room heating with standard room temperature
- Room heating with comfort room temperature
- Backs up DHW heating in On/Off status or by schedule (Auto mode), depending on the Viessmann appliance.

Operating programs

- Frost protection is active.
- Heating is active.

- "Extended heating"/"Extend time phase once" is active.
- DHW is heated according to the time program.
- DHW heating is permanently off.
- DHW heating is permanently on.

Messages

- Fault
- Replace the batteries.

Symbols during operation

- While settings are being made.
- Time program: Active time phase

Standby

If no settings are made at the remote control for at least 5 seconds, the display backlighting switches off.

To end standby:

Press any button.
The display lights up. The home screen is displayed.

Using the remote control (cont.)









Locking/unlocking the controls

To activate/deactivate the operating buttons (child lock), press **OK** for approx. 3 seconds. The "Child lock" function must be activated once: See page 26.

Operating programs for central heating and DHW heating

Note

The operating programs for central heating and DHW heating can be set separately.

Display	Operating program	Function
Room heating		
 and one of the following symbols is displayed: <ul style="list-style-type: none"> ▪  ▪  ▪  	"Heating mode"	The rooms of the selected heating circuit are heated in accordance with the specifications for the room temperature and the time program (see chapter "Central heating").
The symbol  is no longer displayed.	"Standby mode"	<ul style="list-style-type: none"> ▪ No central heating ▪ Frost protection for the Viessmann appliance is active. "Standby mode" can only be activated and deactivated on the Viessmann appliance. To switch off heating via the Vitotrol 100-E, the lowest settings for the temperature levels can only be selected in the "heating mode" operating program.
DHW heating		
 Auto	DHW heating according to time program	DHW is heated in accordance with the specifications for the DHW temperature and the time program (see chapter "DHW heating").
 On	DHW heating is permanently on.	DHW is permanently heated to the set DHW temperature regardless of a time program (see chapter "DHW heating").
 Off	DHW heating is permanently off.	<ul style="list-style-type: none"> ▪ No DHW heating (see chapter "DHW heating") ▪ Frost protection for the DHW cylinder is enabled.

Special operating programs and functions

▪ Screed drying:

This function is activated by your contractor at the control unit of the Viessmann appliance (if the Viessmann appliance supports this function). Your screed is dried in line with a set time program (temperature/time profile) suitable for the relevant building materials. Your settings for room heating have no effect on the duration of screed drying (max. 32 days). The system no longer provides DHW heating. The "Screed drying" function can be altered or switched off by your contractor.



Control unit of the Viessmann appliance

▪ External hook-up:

The operating program set at the control unit was changed over by an external device, e.g. an EM-EA1 extension (DIO electronics module). The operating program cannot be changed via the control unit or remote control while the external hook-up is active.



Control unit of the Viessmann appliance

▪ "Extended heating"/"Extend time phase once":

See page 24.

Procedure for setting a time program

The following explains how to enter the settings for a time program. The specifics of the individual time programs can be found in the relevant chapters.

Time programs and time phases

In the time programs, you specify what your heating system should do at what time. To do so, divide the day into sections. These are called **time phases**. Different temperature levels are enabled within and outside these time phases.

You can set up a time program for the following functions:

Function	Setting on the Viessmann device	Function	
		Within the time phase	Outside the time phase
Central heating	<ul style="list-style-type: none"> ▪ Remote control ▪ Control unit of the Viessmann appliance 	Your rooms are heated to standard room temperature or comfort room temperature.	Your rooms are heated to reduced room temperature.
DHW heating	<ul style="list-style-type: none"> ▪ Remote control ▪ Control unit of the Viessmann appliance 	DHW heating is switched on. The water in the DHW cylinder is heated to the set DHW temperature.	Domestic hot water heating is switched off.

Procedure for setting a time program (cont.)

Setting time phases

Explanation of the procedure using the example of room heating

You can set up to 4 time phases in each "Time program".

For each time phase, you define the start point "START" and the end point "END".

Example:

"Time program" for "Monday"

- Time phase 1:
06:30 to 12:00 with the normal room temperature ☀
 - Time phase 2:
15:00 to 20:00 with comfort room temperature ∩
- In between these time phases the rooms are heated with the reduced temperature ☹.

Press the following buttons:

1. ☰
2. ▲ / ▼ for "SCHEDULE"
3. OK to confirm
4. ▲ / ▼ for a group of days or a single day
 - "MO-FR" Set the same time phase for all days.
 - "SA-SU" Set the same time phase for all days of the weekend.
 - "MO-SU" Set the same time phase for all days.
 - MON, TUE... Set the time phase for individual days.

The days are shown in abbreviated form or as numbers. To change the type of display: See page 26.

How the days of the week are shown:

MON
TUE
WED
THU
FRI
SAT
SUN

5. OK to confirm

Changing time phase 1:

If you want to start changing another time phase, use ▲ / ▼ to select it and confirm with OK.

1. ▲ / ▼ to set the hour for the start of the time phase ("START") to 6.
2. OK to confirm.

3. ▲ / ▼ to set the minutes for the start of the time phase ("START") to 30 minutes.
4. OK to confirm
5. ▲ / ▼ for the required temperature level "NORMAL"
6. OK to confirm
7. ▲ / ▼ to set the hour for the end of the time phase ("END") to 12.
8. OK to confirm.
9. ▲ / ▼ to set the minutes for the end of the time phase ("END") to 00 minutes.
10. OK to confirm

Setting new time phase 2:

1. ▲ / ▼ to set the hour for the start of the time phase ("START") to 15.
2. OK to confirm.
3. ▲ / ▼ to set the minutes for the start of the time phase ("START") to 00 minutes.
4. OK to confirm
5. ▲ / ▼ for the required temperature level "COMFORT"
6. OK to confirm
7. ▲ / ▼ to set the hour for the end of the time phase ("END") to 22.
8. OK to confirm.
9. ▲ / ▼ to set the minutes for the end of the time phase ("END") to 00 minutes.
10. OK twice to confirm

Finalising the time phase settings:

If a setting is not made for all possible time phases, the first time phase that is not used must be set to "--:--". Only then are the time phase settings finalised

1. ▲ / ▼ to set the hour for the start of the time phase ("START") to --:--.
2. OK twice to confirm.

Procedure for setting a time program (cont.)









Deleting time phases

Explanation of the procedure using the example of room heating

Example:

For **Monday** you want to delete time phase 2.

Press the following buttons:

1. 
2.  /  for "SCHEDULE"
3. **OK** to confirm
4.  /  for the required day or a group of days.
5. **OK** to confirm
6.  /  for the required time phase 2
7. **OK** to confirm.
8.  /  to set the hour for the start of the time phase ("START") to --:--.

Note

The first time phase cannot be deleted.

9. **OK** to confirm.
The time phase has been deleted.

Adjusting the room temperature

You can adjust the room temperatures for 3 temperature levels:

- Reduced room temperature **"REDUCED"** ☾:
Heat your home to the reduced room temperature at night or during regular absences (not applicable to underfloor heating).
- Normal room temperature **"NORMAL"** ☼:
Heat your home to the standard room temperature during the day.
- Comfort room temperature **"COMFORT"** ⚓:
Heat your home to the comfort room temperature if you want to feel particularly cosy.

Note

You define which temperature level is active via the time program.

Changing the room temperature for the current temperature level





Press the following buttons:



1.  /  to change the current set temperature.

2. **OK** to confirm

Changing the room temperature for further temperature levels

Press the following buttons:

1. 
2.  /  for **"TEMP PROF"**
3. **OK** to confirm
4.  /  for **"COMFORT"**, **"NORMAL"** or **"REDUCED"**

5. **OK** to confirm
6.  /  to change the current set temperature.
7. **OK** to confirm

Time program for central heating

Setting a time program

Factory settings: **One** time phase from 06:00 to 22:00 h for every day of the week

You can change the time program individually in accordance with your requirements.

Press the following buttons:

1. 

2.  /  for **"SCHEDULE"**

3. **OK** to confirm

To continue: See page 21.

Switching central heating on or off

Room heating can only be switched off via the Viessmann appliance, e.g. the heat generator. Alternatively, the set room temperature of the temperature level can be lowered via the Vitotrol 100-E so that the heating is switched off.

For information on the operating programs: See page 19.

Note

If the actual room temperature exceeds the current set room temperature, room heating is automatically switched off.

Central heating

Temporarily adjusting the room temperature

If you want to heat your home with the **normal room temperature** or **comfort room temperature** during a time phase with reduced room temperature, switch on the "Extended heating"/"Extend time phase once"  function.

Your home will be heated with the temperature of the last active time phase for standard room temperature/flow temperature or comfort room temperature/flow temperature.

Switching on "Extended heating"/"Extend time phase once"

Press the following button:



The temperature of the last active time phase for the normal room temperature/flow temperature or comfort room temperature/flow temperature will be selected.

Switching off "Extended heating"/"Extend time phase once"

The function ends automatically when switching to the next time phase for the normal room temperature/flow temperature or comfort room temperature/flow temperature.

To terminate "Extended heating"/"Extend time phase once"  early, press the following button:







The room is heated again according to the set schedule.

Starting DHW heating

DHW is heated according to the set time program.

Press the following buttons:

1. 
2.  /  for "DHW"
3. **OK** to confirm
4.  /  for "DHW ONOFF"
5. **OK** to confirm

If you switch off DHW heating, no water can be heated.

6.  /  for "AUTO"

Note



If the DHW is to be permanently heated to the set DHW temperature independently of a time program, select "ON".

7. **OK** to confirm

Switching off DHW heating

Press the following buttons:

1. 
2.  /  for "DHW"
3. **OK** to confirm

4.  /  for "DHW ONOFF"

5. **OK** to confirm

6.  /  for "OFF"

7. **OK** to confirm

Setting the DHW temperature

Press the following buttons:

1. 
2.  /  for "DHW"
3. **OK** to confirm

4.  /  for "SETPOINT"

5. **OK** to confirm

6.  /  for the required DHW temperature

7. **OK** to confirm

Time program for DHW heating

Setting a time program

Factory settings: 05:30 to 22:00 h

You can change the time program individually in accordance with your requirements.

Press the following buttons:

1. 
2.  /  for "DHW"

3. **OK** to confirm

4.  /  for "DHW SCHED"

5. **OK** to confirm

To continue: See page 21, but without selecting a temperature level.



Further settings

Setting or changing the language

The required language is set during commissioning. You can change the language at any time.

Press the following buttons:

1. 

2.  /  for "LANGUAGE"

3. **OK** to confirm

4.  /  for the required language



5. **OK** to confirm

Enabling the "Lock controls" (child lock) function

Before locking the controls, e.g. against use by children, the function must be enabled once as follows:

Press the following buttons:

1. 

2.  /  for "CHILDLOCK"

3. **OK** to confirm

4.  /  for "ON"



5. **OK** to confirm

The controls can now be locked: See page 19.

Cancelling activation of the "Controls lock-out" (child lock) function

Press the following buttons:

1. 

2.  /  for "CHILDLOCK"

3. **OK** to confirm

4.  /  for "OFF"

5. **OK** to confirm

Software update

If WiFi is activated on the Viessmann appliance and a software update is available, the software is automatically updated. The software is transmitted to the remote control via low power radio and updated. The remote control then switches off for up to 2 minutes and restarts.

Note

We recommend connecting the Viessmann appliance permanently to the WiFi so that the Vitotrol 100-E software is always up to date.

Setting the format of the day and time display

You can choose whether the time is shown on the display in 12-hour or 24-hour format.











You can choose between 2 options for displaying the days of the week.

Weekday	Shown as a number (factory setting) Setting "NUMBER" (factory setting for all languages except "English")	Shown as an abbreviation of the English day of the week Setting "WORD" (factory setting when language is set to "English")
Monday	1	MON
Tuesday	2	TUE
Wednesday	3	WED
Thursday	4	THU
Friday	5	FRI

Setting the format of the day and time display (cont.)

Weekday	Shown as a number (factory setting) Setting "NUMBER" (factory setting for all languages except "English")	Shown as an abbreviation of the English day of the week Setting "WORD" (factory setting when language is set to "English")
Saturday	6	SAT
Sunday	7	SUN

Press the following buttons:

1. 
2.  /  for "TIME DATE"
3. **OK** to confirm
4.  /  for "FORMAT"
5. **OK** to confirm
6.  /  for "12" or "24"
7. **OK** to confirm
8.  /  for "WEEK TYPE"
9. **OK** to confirm
10.  /  for the required display
11. **OK** to confirm







Restoring factory settings

Restore the factory settings of your remote control, for example if the remote control has already been commissioned with a different Viessmann appliance. All settings changed by you are restored to the delivered condition.

Note

Your contractor has to update the settings for the remote control on the control unit of your Viessmann appliance too, e.g. heat generator.

Press the following buttons:

1. 
2.  /  for "RESET"
3. **OK** to confirm
4.  /  for "ON"
5. **OK** to confirm
6. Enter PIN "1917". To do this, select each number individually:
 -  /  for the required number
 - **OK** to confirm
7. **OK** to confirm the prompt
The remote control is reset to the factory settings. The remote control is restarted. Initial commissioning of the remote control must be carried out again: See page 15. The connected Viessmann appliance also needs to be restarted to re-establish the connection to the remote control. All other settings of the Viessmann appliance are retained. The Whether frost protection only is active for the Viessmann appliance and DHW cylinder. Viessmann appliance remains functional.

Calling up device information

In the "DEV INFO" menu you can call up the following information for the Vitotrol 100-E:

Shown on display	Explanations
"SW VERS"	Software version
"RF RANGE"	Signal strength of low power radio in dBm
"ADJUST"	Correction of the actual room temperature that is displayed
"BATT"	Battery charge level in % Replace the batteries when the charge level is below 10 %.

Displaying "DEV INFO"







Press the following buttons:

1. 
2.  /  for "DEV INFO"
3. **OK** to confirm
4.  /  for the required information
5. **OK** to confirm

Correcting the actual room temperature displayed

The actual room temperature that is displayed can be corrected in the range from -5 to +5 °C.





Press the following buttons:

1. 
2.  /  for "DEV INFO"
3. **OK** to confirm
4.  /  for "ADJUST"
5. **OK** to confirm
6.  /  for the required value to correct the display of the actual room temperature.
7. **OK** to confirm

Messages shown on the display

If messages have arisen on your heating system or your remote control, the  symbol is shown on the display.

Messages shown on the display (cont.)

Display	Meaning	Remedy
ERR CONN	The low power radio connection to the Viessmann appliance has been interrupted.	<ul style="list-style-type: none"> ▪ Check whether your Viessmann appliance is switched on. ▪ Check whether "low power radio" on your Viessmann appliance is activated.  Operating instructions for the Viessmann appliance ▪ Check the signal strength of the "low power radio" in the "DEV INFO" menu of your Vitotrol 100-E: See page 28. ▪ If necessary, move the Vitotrol 100-E to a different installation location: See page 11. ▪ Restart the Vitotrol 100-E: See page 30. ▪ Switch your Viessmann appliance off and on again.  Operating instructions for the Viessmann appliance ▪ Return your Vitotrol 100-E to the factory settings: See page 27. Repeat the commissioning process: See page 15.
ERR SYS and an exclamation mark	A fault has occurred on the connected Viessmann appliance.	<p>Find out about the fault on the display of the Viessmann appliance and notify your contractor.</p> <p> Operating instructions for the Viessmann appliance</p>
ERR DEV	A fault has occurred in the Vitotrol 100-E.	Replace the Vitotrol 100-E.
	The batteries have nearly run out.	Replace the batteries: See page 32.

What to do if...

Faults without fault display

All displays on the Vitotrol 100-E are off.

Cause	Remedy
The batteries in the Vitotrol 100-E have nearly run out.	Replace the batteries: See page 32.

Cause of fault could not be found

Find out about any possible troubleshooting measures at the control unit of your Viessmann appliance and notify your contractor.



Operating instructions for the Viessmann appliance

Restarting the Vitotrol 100-E

Remove the batteries from your remote control for at least 10 seconds.

After the batteries are reinserted, the device restarts.

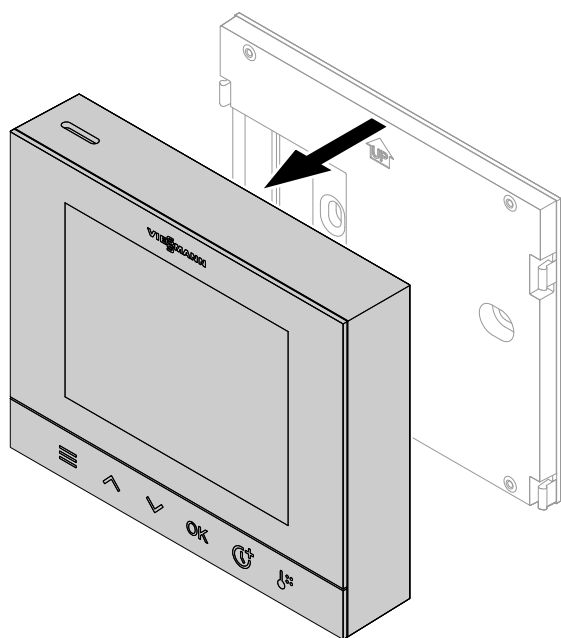

Fig. 8

Restarting the Vitotrol 100-E (cont.)

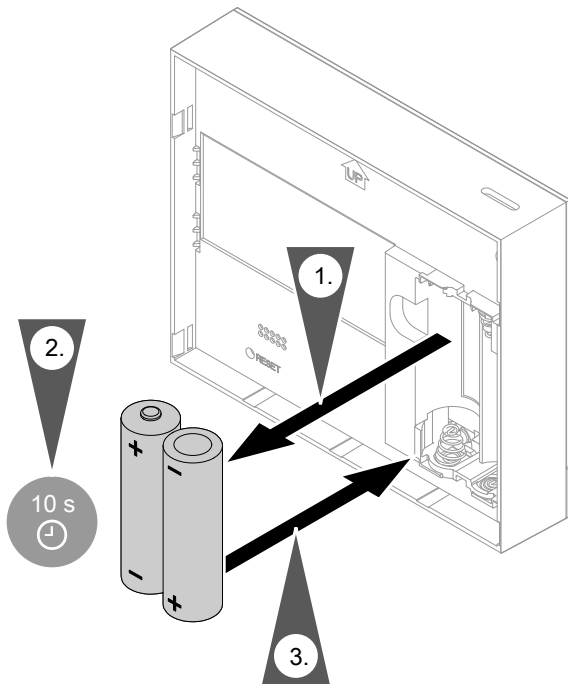

Fig. 9

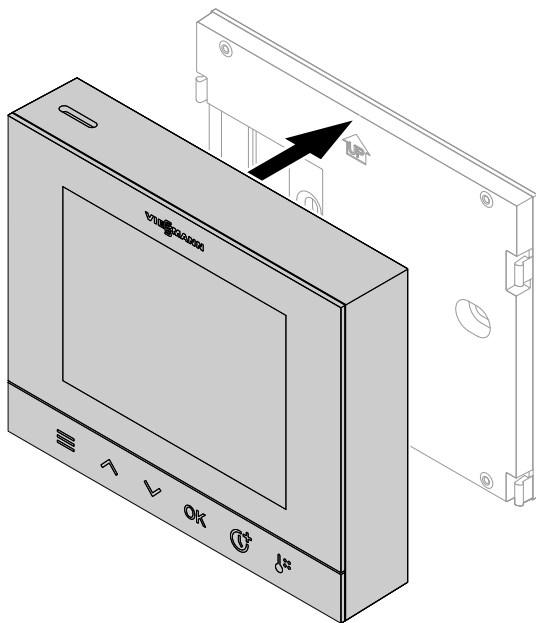

Fig. 10

Replacing the batteries

We recommend the use of AA batteries as they last longer than rechargeable ones.

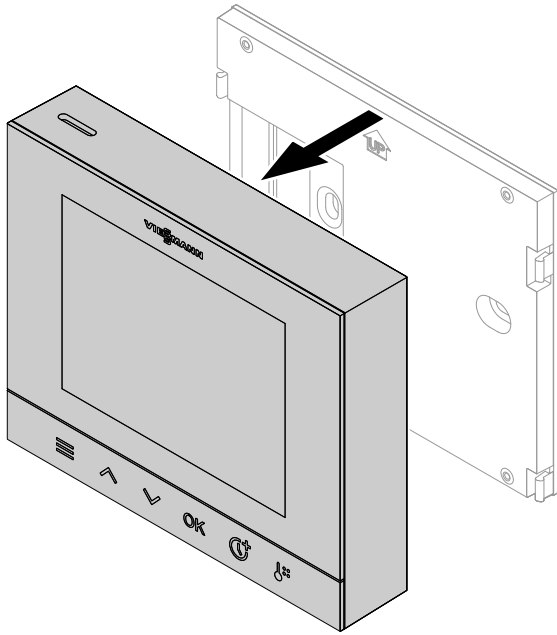

Fig. 11

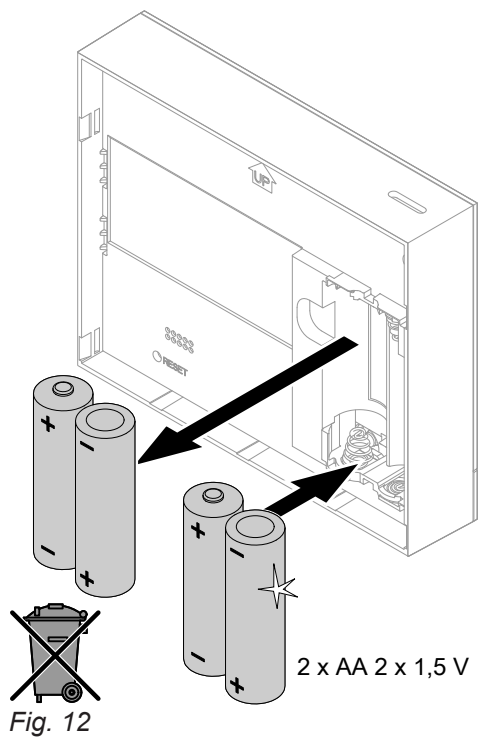

Fig. 12

Replacing the batteries (cont.)

Fig. 13

After the batteries are inserted, the remote control adopts all settings from the connected Viessmann appliance.

Cleaning

You can clean the surfaces of the device with a micro-fibre cloth. Never use cleaning agents.

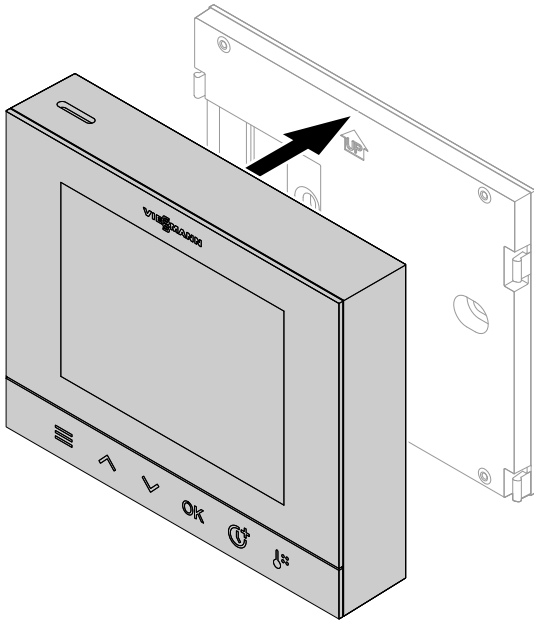
Specification

Specification

Vitotrol 100-E

Power supply	Via batteries: 2 x 1.5 V AA (LR06)
Protection class	III
IP rating	IP 20D to EN 60529, ensure through design/installation.
Low Power Radio Status	
Radio frequency	2.4 GHz
Encryption	Encrypted
Wireless range through walls	Up to 14 m (depending on wall thickness and wall type)
Permissible ambient temperature	
▪ Operation	+5 to +40 °C Installation in living spaces or boiler rooms (normal ambient conditions). Do not install in wet rooms, e.g. bathrooms.
▪ Storage and transport	-20 to +60 °C

Licences

This product comprises third party software and/or open source software. You are authorised to use this software subject to compliance with the relevant licensing terms.

The following open-source software components are used in the Vitotrol 100-E:

No.	Name	Version	Download URL	Licence
1	Mbed TLS	2.7.12	https://github.com/Mbed-TLS/mbedtls	APACHE-2.0
2	CMSIS	5.3.0	https://github.com/ARM-software/CMSIS_5	APACHE-2.0

APACHE-LIZENZ/Version 2.0

APACHE License Version 2.0,
January 2004
<http://www.apache.org/licenses/>

TERMS AND CONDITIONS FOR USE, REPRODUCTION, AND DISTRIBUTION

1. Definitions

"License" shall mean the terms and conditions for use, reproduction, and distribution as defined by Sections 1 through 9 of this document.

"Licensor" shall mean the copyright owner or entity authorized by the copyright owner that is granting the License.

"Legal Entity" shall mean the union of the acting entity and all other entities that control, are controlled by, or are under common control with that entity. For the purposes of this definition, "control" means (i) the power, direct or indirect, to cause the direction or management of such entity, whether by contract or otherwise, or (ii) ownership of fifty percent (50 %) or more of the outstanding shares, or (iii) beneficial ownership of such entity.

"You" (or "Your") shall mean an individual or Legal Entity exercising permissions granted by this License.

"Source" form shall mean the preferred form for making modifications, including but not limited to software source code, documentation source, and configuration files.

"Object" form shall mean any form resulting from mechanical transformation or translation of a Source form, including but not limited to compiled object code, generated documentation, and conversions to other media types.

"Work" shall mean the work of authorship, whether in Source or Object form, made available under the License, as indicated by a copyright notice that is included in or attached to the work (an example is provided in the "Appendix" below).

"Derivative Works" shall mean any work, whether in Source or Object form, that is based on (or derived from) the Work and for which the editorial revisions, annotations, elaborations, or other modifications represent, as a whole, an original work of authorship. For the purposes of this License, Derivative Works shall not include works that remain separable from, or merely link (or bind by name) to the interfaces of, the Work and Derivative Works thereof.

"Contribution" shall mean any work of authorship, including the original version of the Work and any modifications or additions to that Work or Derivative Works thereof, that is intentionally submitted to Licensor for inclusion in the Work by the copyright owner or by an individual or Legal Entity authorized to submit on behalf of the copyright owner. For the purposes of this definition, "submitted" means any form of electronic, verbal, or written communication sent to the Licensor or its representatives, including but not limited to communication on electronic mailing lists, source code control systems, and issue tracking systems that are managed by, or on behalf of, the Licensor for the purpose of discussing and improving the Work, but excluding communication that is conspicuously marked or otherwise designated in writing by the copyright owner as "Not a Contribution".

"Contributor" shall mean Licensor and any individual or Legal Entity on behalf of whom a Contribution has been received by Licensor and subsequently incorporated within the Work.

2. Grant of Copyright License

Subject to the terms and conditions of this License, each Contributor hereby grants to You a perpetual, worldwide, non-exclusive, no-charge, royalty-free, irrevocable copyright license to reproduce, prepare Derivative Works of, publicly display, publicly perform, sublicense, and distribute the Work and such Derivative Works in Source or Object form.

3. Grant of Patent License

Subject to the terms and conditions of this License, each Contributor hereby grants to You a perpetual, worldwide, non-exclusive, no-charge, royalty-free, irrevocable (except as stated in this section) patent license to make, have made, use, offer to sell, sell, import, and otherwise transfer the Work, where such license applies only to those patent claims licensable by such Contributor that are necessarily infringed by their Contribution(s) alone or by combination of their Contribution(s) with the Work to which such Contribution(s) was submitted. If You institute patent litigation against any entity (including a cross-claim or counterclaim in a lawsuit) alleging that the Work or a Contribution incorporated within the Work constitutes direct or contributory patent infringement, then any patent licenses granted to You under this License for that Work shall terminate as of the date such litigation is filed.

4. Redistribution

You may reproduce and distribute copies of the Work or Derivative Works thereof in any medium, with or without modifications, and in Source or Object form, provided that You meet the following conditions:

- a) You must give any other recipients of the Work or Derivative Works a copy of this License; and
- b) You must cause any modified files to carry prominent notices stating that You changed the files; and
- c) You must retain, in the Source form of any Derivative Works that You distribute, all copyright, patent, trademark, and attribution notices from the Source form of the Work, excluding those notices that do not pertain to any part of the Derivative Works; and
- d) If the Work includes a "NOTICE" text file as part of its distribution, then any Derivative Works that You distribute must include a readable copy of the attribution notices contained within such NOTICE file, excluding those notices that do not pertain to any part of the Derivative Works, in at least one of the following places: within a NOTICE text file distributed as part of the Derivative Works; within the Source form or documentation, if provided along with the Derivative Works; or, within a display generated by the Derivative Works, if and wherever such third-party notices normally appear. The contents of the NOTICE file are for informational purposes only and do not modify the License. You may add Your own attribution notices within Derivative Works that You distribute, alongside or as an addendum to the NOTICE text from the Work, provided that such additional attribution notices cannot be construed as modifying the License.

You may add Your own copyright statement to Your modifications and may provide additional or different license terms and conditions for use, reproduction, or distribution of Your modifications, or for any such Derivative Works as a whole, provided Your use, reproduction, and distribution of the Work otherwise complies with the conditions stated in this License.

5. Submission of Contributions

Unless You explicitly state otherwise, any Contribution intentionally submitted for inclusion in the Work by You to the Licensor shall be under the terms and conditions of this License, without any additional terms or conditions. Notwithstanding the above, nothing herein shall supersede or modify the terms of any separate license agreement you may have executed with Licensor regarding such Contributions.

6. Trademarks

This License does not grant permission to use the trade names, trademarks, service marks, or product names of the Licensor, except as required for reasonable and customary use in describing the origin of the Work and reproducing the content of the NOTICE file.

7. Disclaimer of Warranty

Unless required by applicable law or agreed to in writing, Licensor provides the Work (and each Contributor provides its Contributions) on an "AS IS" BASIS, WITHOUT WARRANTIES OR CONDITIONS OF ANY KIND, either express or implied, including, without limitation, any warranties or conditions of TITLE, NON-INFRINGEMENT, MERCHANTABILITY, or FITNESS FOR A PARTICULAR PURPOSE. You are solely responsible for determining the appropriateness of using or redistributing the Work and assume any risks associated with Your exercise of permissions under this License.

8. Limitation of Liability

In no event and under no legal theory, whether in tort (including negligence), contract, or otherwise, unless required by applicable law (such as deliberate and grossly negligent acts) or agreed to in writing, shall any Contributor be liable to You for damages, including any direct, indirect, special, incidental, or consequential damages of any character arising as a result of this License or out of the use or inability to use the Work (including but not limited to damages for loss of goodwill, work stoppage, computer failure or malfunction, or any and all other commercial damages or losses), even if such Contributor has been advised of the possibility of such damages.

Licences (cont.)

9. Accepting Warranty or Additional Liability

While redistributing the Work or Derivative Works thereof, You may choose to offer, and charge a fee for, acceptance of support, warranty, indemnity, or other liability obligations and/or rights consistent with this License. However, in accepting such obligations, You may act only on Your own behalf and on Your sole responsibility, not on behalf of any other Contributor, and only if You agree to indemnify, defend, and hold each Contributor harmless for any liability incurred by, or claims asserted against, such Contributor by reason of your accepting any such warranty or additional liability.

END OF TERMS AND CONDITIONS

APPENDIX: How to apply the Apache License to your work

To apply the Apache License to your work, attach the following boilerplate notice, with the fields enclosed by brackets "[]" replaced with your own identifying information. (Don't include the brackets!) The text should be enclosed in the appropriate comment syntax for the file format. We also recommend that a file or class name and description of purpose be included on the same "printed page" as the copyright notice for easier identification within third-party archives.

Copyright [yyyy] [name of copyright owner]
Licensed under the Apache License, Version 2.0 (the "License"); you may not use this file except in compliance with the License. You may obtain a copy of the License at <http://www.apache.org/licenses/LICENSE-2.0>

Unless required by applicable law or agreed to in writing, software distributed under the License is distributed on an "AS IS" BASIS, WITHOUT WARRANTIES OR CONDITIONS OF ANY KIND, either express or implied. See the License for the specific language governing permissions and limitations under the License.

Terminology

Standby mode

Standby mode can only be set on your connected Viessmann appliance.
Heat generation for the heating circuit is switched off.

Only boiler frost protection is active. No room heating, no DHW heating

Setback mode (reduced heating mode)

See "Reduced heating mode".

Operating program

You define the following with the operating program:

- How you heat your rooms.
- Whether you heat DHW.
- Whether frost protection only is active for the Viessmann appliance and DHW cylinder.

Screed drying

Your contractor can activate this function for screed drying, for example in your new build or extension. This means your screed is dried in line with a fixed time program (temperature/time profile) that is appropriate for the building materials used.

Terminology (cont.)

Screed drying affects all heating circuits:

- All rooms are heated according to the temperature/time profile.
Your settings for central heating have no effect on the duration of screed drying (max. 32 days).
- DHW heating is enabled.

Underfloor heating system

Underfloor heating systems are slow low temperature heating systems and respond only very slowly to short term temperature changes.

Heating with reduced room temperature at night therefore does not result in any significant energy savings.

Heating mode

Standard heating mode or comfort heating mode

For periods when you will be at home during the day, heat your rooms to the standard room temperature or comfort room temperature.

Reduced heating mode

For periods when you will be absent or during the night, heat your rooms to the reduced room temperature. With underfloor heating systems, reduced heating mode only yields limited energy savings (see "Underfloor heating system").

Weather-compensated heating mode

In weather-compensated mode, the flow temperature is controlled according to the outside temperature. More heat is made available at a lower outside temperature than at a higher one. The outside temperature is captured and transmitted to the control unit by a sensor. The sensor is fitted to the exterior of the building.

Heating circuit

A heating circuit is a sealed unvented circuit connecting the heat generator and the radiators, in which the heating water circulates.

There may be several heating circuits combined in one system. For example, one heating circuit for the rooms occupied by you and one heating circuit for the rooms of a separate apartment.

Night setback

See "Reduced heating mode"

Room heating

Room heating is carried out with different temperature levels (see "Heating mode").

The changeover between the temperature levels for room heating is set via a time program (see "Time program").

Terminology (cont.)

Room temperature

- Standard room temperature or comfort room temperature:
Set the standard room temperature or comfort room temperature for periods when you are at home during the day.
- Reduced room temperature:
For periods when you will be absent or during the night, set the reduced room temperature: See "Setting the room temperature".

Actual room temperature

Room temperature currently measured at the Vitotrol 100-E

Set temperature

Specific temperature that should be reached, e.g. set DHW temperature.

Time program

In the time programs, you specify what your system should do at what time.

Final decommissioning and disposal of the remote control

Viessmann products can be recycled. Components and fluids from your heating system do not belong in ordinary domestic waste.
Contact your heating contractor regarding correct disposal of your old system.

DE: Operating fluids (e.g. heat transfer medium) can be disposed of at municipal collection points.

AT: Operating fluids (e.g. heat transfer medium) can be disposed of at municipal collection points (ASZ).

RoHS
compliant
2011 / 65 / EU

Keyword index

- A**
 Actual room temperature, correcting..... 28
 Ambient temperature Vitotrol 100-E..... 11
 Angle of penetration..... 12
- B**
 Batteries..... 13
 Battery replacement..... 18, 32
- C**
 Central heating
 – Comfort..... 10
 – Energy saving..... 9
 – Operating program..... 19
 – Room temperature..... 23
 – Switching off..... 23
 – Switching on..... 23
 – Time phases..... 23
 – Time program..... 23
 Child lock..... 19
 Cleaning..... 33
 Comfort (tips)..... 10
 Commissioning..... 15
 – Control unit of Viessmann appliance..... 9
 – Remote control..... 9
 Controls
 – Locking..... 19
 – Unlocking..... 19
- D**
 Days of week
 – Changing..... 26
 Default display..... 18
 Default factory setting..... 9
 Delivered condition..... 9, 27
 Device info display..... 28
 Device insertion into mounting base..... 16
 DHW heating
 – Comfort..... 10
 – DHW temperature..... 25
 – Energy saving..... 9
 – Operating program..... 19
 – Time phases..... 25
 – Time program..... 25
 DHW temperature setting..... 25
 Display days of week
 – Changing..... 26
- E**
 Email..... 6
 Energy saving (tips)..... 9
 External hook-up..... 20
- F**
 Factory setting..... 9
 Factory settings, restore..... 27
 Fault display..... 30
 Fault message..... 18
 Faults..... 28
- Frost protection..... 6
 Frost protection monitoring..... 23
- G**
 General Terms and Conditions..... 6
 Glossary..... 37
- H**
 Heating
 – Comfort..... 10
 – Energy saving..... 9
 Heating times setting..... 21
 Home screen..... 18
- I**
 Information..... 8
 Initial start-up
 – Remote control..... 9
 Installation..... 13
 Installation location..... 11
 Intended use..... 8
- L**
 Language
 – Changing..... 26
 – Setting..... 26
 Liability..... 6
 Low power radio..... 15
- M**
 Malfunction..... 30
 Measures for troubleshooting..... 30
 Messages..... 28
 Mounting base
 – Fitting..... 13
 – Inserting device..... 16
- N**
 Network operator..... 6
 Night setback..... 38
- O**
 Operating program
 – Central heating, DHW..... 19
 – Special..... 20
 – Terminology..... 37
 Operational reliability..... 6
- P**
 Power failure..... 9
 Power supply
 – Batteries..... 13
 Product information..... 8
- R**
 Range, WiFi connections..... 11
 Reception quality..... 11
 Remote control
 – Commissioning..... 15
 – Uninstalling..... 15

Keyword index (cont.)

Remote control use.....	17	Temperature level.....	23
Requirements.....	6	Terminology.....	37
Reset.....	27	Terms and Conditions.....	6
Restart Vitotrol 100-E.....	30	Time.....	26
Room heating		Time phase deletion.....	22
– Symbol.....	18	Time phases	
Room temperature.....	9	– Central heating.....	23
– Changing.....	23	– DHW heating.....	25
Room temperature.....	10	Time phase setting.....	21
		Time program.....	9
		– Central heating.....	23
		– DHW circulation pump.....	10
		– DHW heating.....	10, 25
		– Explanation.....	39
		– Heating circuits.....	10
		– Setting.....	18, 20
		Tips	
		– Comfort.....	10
		– Energy saving.....	9
		Troubleshooting.....	30
S		U	
Screed drying.....	20	Update.....	26
Setback mode.....	37		
Settings.....	18	W	
Software update.....	26	Wall mounting bracket fitting.....	13
Specification.....	34	WiFi connections, range.....	11
Standard setting.....	27	Winter mode.....	37
Standby mode.....	9, 37		
Standby screen.....	18		
Summer mode.....	37		
Supported control units.....	8		
Switching off			
– Central heating.....	23		
Switching on			
– Central heating.....	23		
Symbols.....	18		
System requirements.....	6		
T			
Temperature			
– DHW.....	25		
– Room temperature.....	23		
Temperature, individual preferred.....	10		



Viessmann Climate Solutions SE
35108 Allendorf / Germany
Telephone: +49 6452 70-0
Fax: +49 6452 70-2780
www.viessmann.com



Viessmann Limited
Hortonwood 30, Telford
Shropshire, TF1 7YP, GB
Telephone: +44 1952 675000
Fax: +44 1952 675040
E-mail: info-uk@viessmann.com

6192459 Subject to technical modifications.